



NEXT GENERATION VERTICAL TRANSPORTATION  
*with the state of Advanced Technology*

**BONUM<sup>®</sup>**



**BONUM<sup>®</sup>**

BONUM INDUSTRIES PVT. LTD. Feel proud to provide comfort, easy & luxury to the human kind by being in the Industry of elevators. Elevator is no more just a luxury, but rather a necessity to lead a hectic & fast life. Bonum Elevators is a leading manufacturer & installer of high - quality world class elevators catering to different applications. With an experience of more than a decade, Bonum Elevators boasts of efficient team of staff and engineers.

Bonum Elevators synonymous with reliability & safety was founded for servicing & after sales of other key brands of elevators. With early acceptance & trust, we started designing, manufacturing & installation of elevators by our own brand- Bonum Elevators. In a short span, we have been successful in providing our products to array of Industries in Private, Government & Semi-Government Organizations.



We offer state of the art Escalator and moving walks with multiple options and configurations.

In addition to the innovative design to enhance the looks of the product, we back it up with detailed engineering to provide smooth transit with energy efficiency. We back our products with competent workforce for execution of projects and also for maintenance. Our workforce is trained to provide suitable support whenever necessary.

*Vision:*

To be an organization that is perpetually innovative, reliable and sustainable delivering value to its customers through its services and best quality.

## Machinery

Our Machineries for the productions high quality Elevator Products



STRENGTH | RELIABILITY | AMPLIFIED



## Passenger Elevators

We are the manufacturer of highly efficient Passenger Elevators using premier Raw Material. Particularly designed by our professionals these lifts are used for carrying passengers from one floor to another. These lifts are designed in different forms like power coated or stainless steel with Matt finished stainless steel by our professionals.



## Goods Elevators



For carrying various sized goods and equipment from one floor to another, we design and develop Goods Elevators. These elevators are designed with utmost precision and thus, ensure noiseless operation. Clients appreciate these goods elevators for having excellent load bearing capacity with slow speed and smooth running operation.

## Hospital Lift

We offer Hospital Lifts for Hospitals for easy transportation of bulky equipments as well as patients. These are apt to meet the modern day hospital needs. These have sophisticated looks with high functionality. Hospital Lifts are best to carry gurneys, stretchers as well as wheel chairs. We offer these at attractive prices and in various models.



## STRENGTH | RELIABILITY | AMPLIFIED

**Auto Door Range of Product Available as mention bellow.**

Fermator	Wittur	Synergy
700/800, 900, 1000, 1100, 1200 Landing Doors Available in MS, SS, SV (SS), SV(MS), BV, HV	700/800, 900, 1000, 1100, 1200 Landing Doors Available in MS, SS, SV (SS), SV(MS), BV, HV	700/800, 900, 1000, 1100, 1200 Landing Doors Available in MS, SS, SV (SS), SV(MS), BV, HV
700/800, 900, 1000, 1100, 1200 Car Doors Available in MS, SS, SV (SS), SV(MS), BV, HV	700/800, 900, 1000, 1100, 1200 Car Doors Available in MS, SS, SV (SS), SV(MS), BV, HV	700/800, 900, 1000, 1100, 1200 Car Doors Available in MS, SS, SV (SS), SV(MS), BV, HV

### Passenger Elevators



We are one of the renowned manufacturers and suppliers of elevators that have gained wide appreciation for operational excellence. These hydraulic elevators are precision engineered using advanced technology to offer best performance. They are compact in size and includes trolley mounted steel frame, hand pumps, top platform, hydraulic cylinders and scissors kind of steel bracing. Also, they can carry load holding at any height as a safety attribute to avoid any accidental slide down of the platform.

### Goods Elevators

We are known for our effective variety of MRL Elevators. which do not required any space to save and machine room. These products are manufactured under the guidance of our quality experts and have various qualities like high performance, light weighted, efficient, reduced motor size, tensile strength and long life. We offer these products with high rates of travel than hydraulic elevators.



### Hospital Lift



Dumb waiter systems have always been critical in restaurants, hotels and other food service to make sure the food gets to the customer piping hot and without getting dropped on the stairs, and in all cases the service lift is about the right tool for the job, keeping any passenger lifts clear of "backstage work going on and designed to take up a minimum of space with a maximum of load carrying capability.

## LIFT MOTOR PARTS AND EQUIPMENTS

### COMPLETE SET LIFT GEAR MACHINE :

We offer you the suitable complete set of Lift Gear Manufactured by M/s. **BONUM**, both have more than Eighteen years experience in the field of Manufacturing Elevator Traction Machine and Parts to urban development. As an Indian leader in the industry. The Company is dedicated to excellence in products and customer services.



Gearless Montenary Motor 5-30HP



Hena Motor 10HP



Sharp Motor 5-40HP



Bharat Bijli Gearless MRL Motor



Bonum Motor 5-10HP



Bonum Motor 5-10HP

## PERSONALIZE YOUR OWN FLOORING

CHOOSE YOUR FLOORING

### PVC MATERIALS

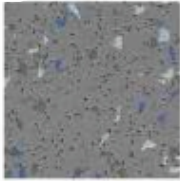

M-1

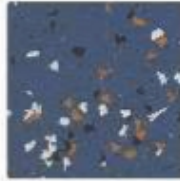

M-2



M-3

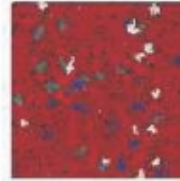

M-4

and  
many more  
option...

### PVC WOODEN MATERIALS



M-5



M-6



M-7



M-8

and  
many more  
option...

### PVC MARBLE FINISH MATERIALS



M-9



M-10



M-11



M-12

and  
many more  
option...

### PVC CARPET FINISH MATERIALS



M-13



M-14



M-15

and  
many more  
option...

### LUXURIOUS OPTION

- ➔ REAL GLASS FLOORING
- ➔ REAL WOOD FLOORING
- ➔ REAL MARBLE FLOORING



### FLOORING PATTERN

AVAILABLE IN MARBLE & PVC



PATTERN 01



PATTERN 02

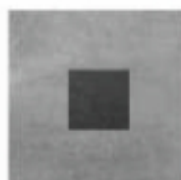

PATTERN 03



PATTERN 04



PATTERN 05

**PERSONALIZE YOUR OWN FLOORING**  
CHOOSE YOUR CEILING

**BONUM<sup>®</sup>**



DESIGN 01



DESIGN 02



DESIGN 03



DESIGN 04



DESIGN 05



DESIGN 06



DESIGN 07



DESIGN 08



DESIGN 09



DESIGN 10



DESIGN 11



DESIGN 12

## PERSONALIZE YOUR OWN FLOORING CHOOSE YOUR DOOR



**01 SS AUTO DOOR**



**02 SS TELESCOPIC DOOR**



**03 GLASS DOOR**



**04 SMALL VISION  
AUTO DOOR**



**05 FULL GLASS DOOR**



**06 MANUAL TELESCOPIC  
DOOR**



**07 SWING DOOR**



**08 COLLIPSBLE DOOR**



**09 IFG DOOR**

## SS SHEET & POWDER COATING OPTIONS

# BONUM<sup>®</sup>

### STANDARD SHEETS



S01



S02

### PREMIUM SHEETS



S03

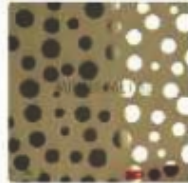

S04

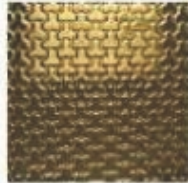

S05



S06

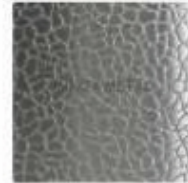

S07

### SUPER PREMIUM SHEETS



S08



S09

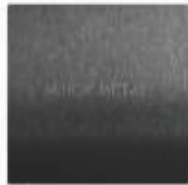

S10



S11



S12

### LUXURIOUS SHEETS

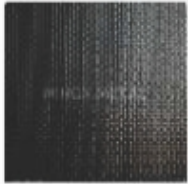

S13



S14



S15



S16

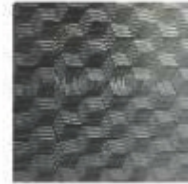

S17

AND MANY MORE...

### POWDER COATING

#### PREMIUM SHEETS

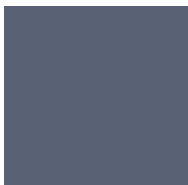
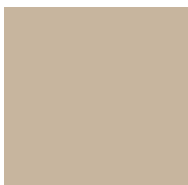
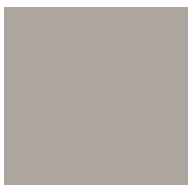
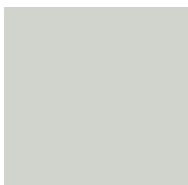
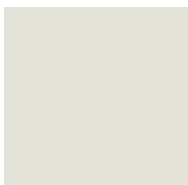

AND MANY MORE...

**PERSONALIZE YOUR OWN LIFT**  
CHOOSE YOUR LAYOUT

**BONUM<sup>®</sup>**



LAYOUT 1



LAYOUT 2

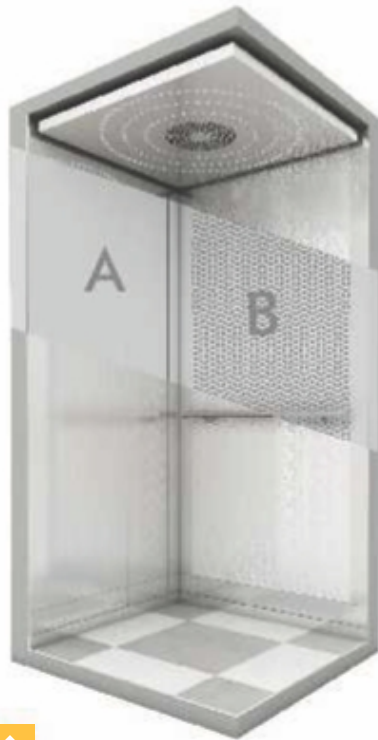

LAYOUT 3



LAYOUT 4

**PERSONALIZE YOUR OWN LIFT**  
CHOOSE YOUR LAYOUT

**BONUM<sup>®</sup>**



LAYOUT 5



LAYOUT 6



LAYOUT 7

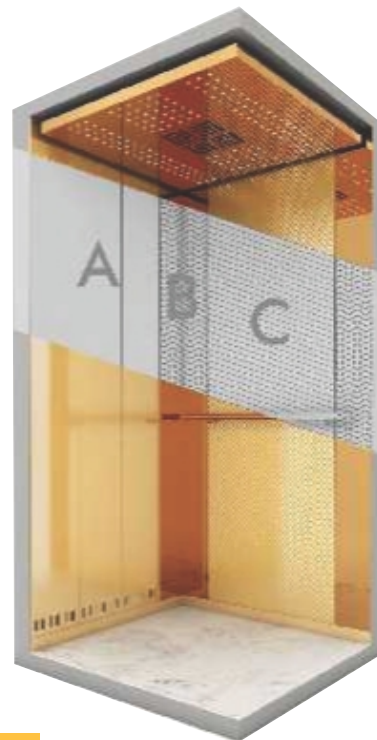

LAYOUT 8

## LIFT CABINS

With our highly specialized knowledge and vast Experience we provide our client with the most qualitative range of Stainlses Steel Lift Cabins. Our proficient technicians design these cabins in custom-built sizes to meet the specifications and requirements of our clients in effective manner.

### Our Range of Lift Cabins:

(1) MS Cabin with Powder Coated

(2) SS (202.304)

(3) SS Golden Cabin



**BONUM<sup>®</sup>**



# BONUM<sup>®</sup>

## CAR OPERATING PANEL

These are Stainless Steel as well as pre-finished Mild Steel face plates embedded into the walls of the cabin and are equipped with micro push buttons with various standard & optional features. They are elegantly designed to fuse with the cabin interiors and enable user friendly experience.



## LANDING OPERATING PANEL

Our landing operating panels are graced with contemporary designs, advanced functionality and updated technology and come with call register type micro push buttons, digital floor position and direction indicators that are elegantly fixed on stainless st and prefinished mild steel face plates.

**Various display options in Seven Segmen ,Scrolling dot matrix & LCD screens are available.**

## HAND RAIL

Handrails go a long way to add to the aesthetics of the cabin and can be very useful for passengers travelling in the elevators as they can on to them while standing as the elevator moves.

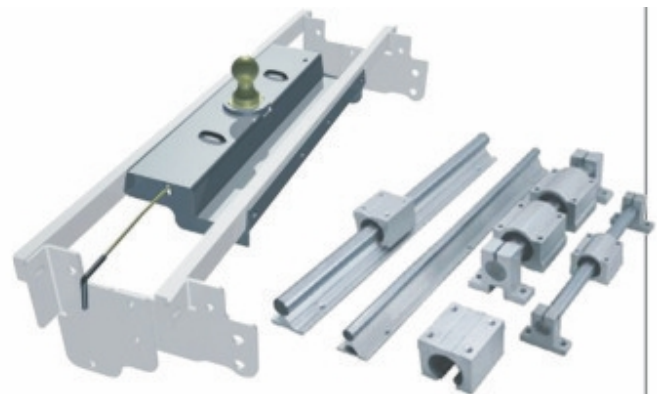

## SAFETY DEVICES

Our safety measures renowned for reliability, flexibility and versatility. Understanding well the safety issues and risks that an elevator can be exposed to our safety devices are designed by adopting-rdge technology and premium quality material that can certainly avoid any risk.



## AUTOMATIC RESCUE DEVICE

An optional device to rescue that trapped passengers and them to the nearest floor promptly.



## COMMUNICATION DEVICES

To enhance safety and convenience of the passengers, we can offer quality communication devices.



## GEARLESS TRACTION MACHINE

Gear less traction machine backed with encoder are specifically designed, developed & integrated to get excellent performance, reliability & energy management. The close loop system further ensures the better ride quality & superior control. These machines are suitable for speed ranging from 1.0 mps to 2.5 mps.

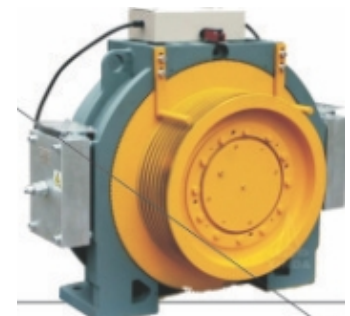

CAR BRACKET

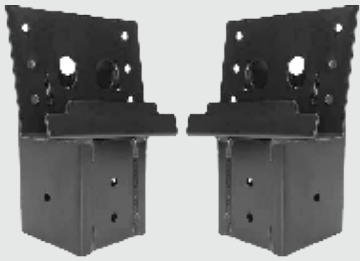

TRACTION MOTOR

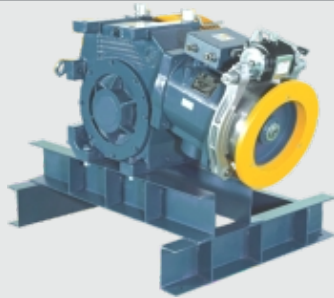

DOOR DRIVE



BDG

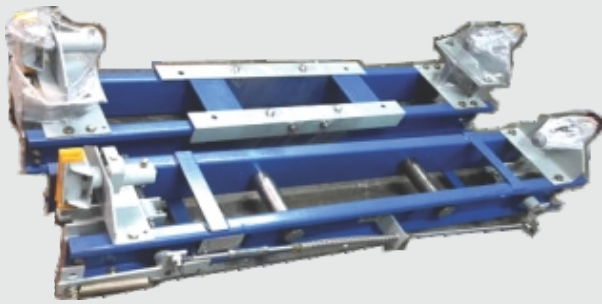

LIMIT SWITCH

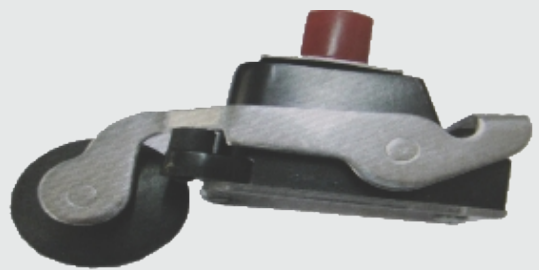

CAR GATE LIMIT



REED SWITCH



REED SWITCH



LOP / COP



MANUAL DOOR



GUIDE SHOE

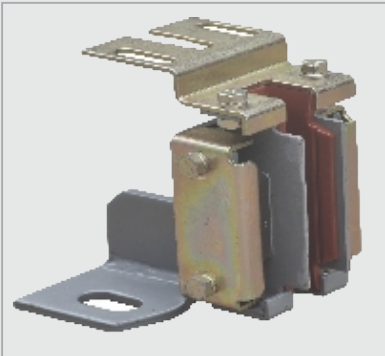

CAR SHOE



DIVERTER PULLY STAND



DIVERTER PULLY



CAR & COUNTER BRACKET



GUIDE RAIL



ELEVATOR CONTROLLER

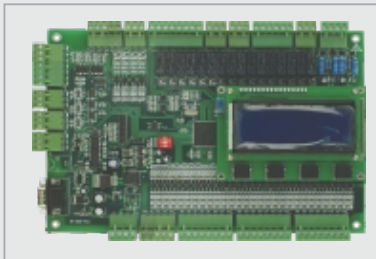

ELEVATOR ROPE



DBG



COUNTER FRAME



BLOWER



## LIFT DOORS

We offer our clients a wide variety of Lift Doors and Door Frames which are manufactured by a premium Quality Material to ensure high durability and Efficient Performance.

### Our Range of Lift Doors are :

- (1) Collapsible Gates
- (2) MS or SS Telescopic Auto Door
- (3) MS or SS Glass Door
- (4) MS or SS Automatic Doors
- (5) Imperforated Doors
- (6) MS or SS Telescopic Manual Doors
- (7) MS or SS Swing Doors



MS Collapsible Door



MS Telescopic Door  
(Manual)



MS Swing Door

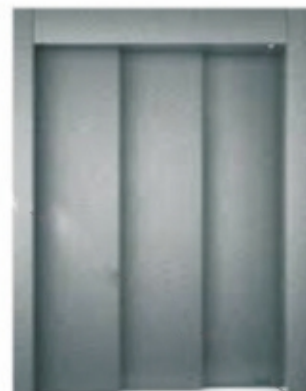

Telescopic Auto Door



SS Door



SS Auto Door



SS Auto Door  
Small Vision



MS Auto Door  
Small Vision

## LIGHTING SYSTEM AT THE SKIRT GUARD

The lighting system at the skirt guard is to provide better visibility at the steps. Thus, it also enhances the safety of the passengers.

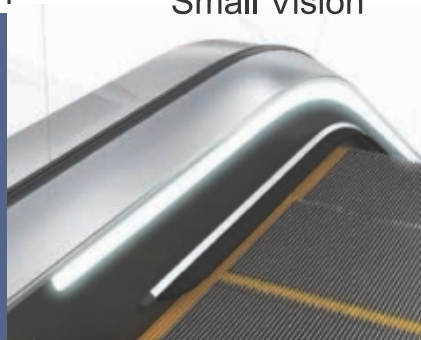

## CABIN INTERIORS

# BONUM<sup>®</sup>

### FALSE CEILING :

False ceiling are designed artfully to enhance the look of the cabin also ensuring that it complements well the make and color of the cabin and adds grace to the elevator. They are available in both prefinished mild steel and stainless steel finish with hairline, moon rock, honey comb and mirror finish depending upon the building aesthetics. LED and CFL lighting options are available to choose from with made to order lighting panels to appearance further

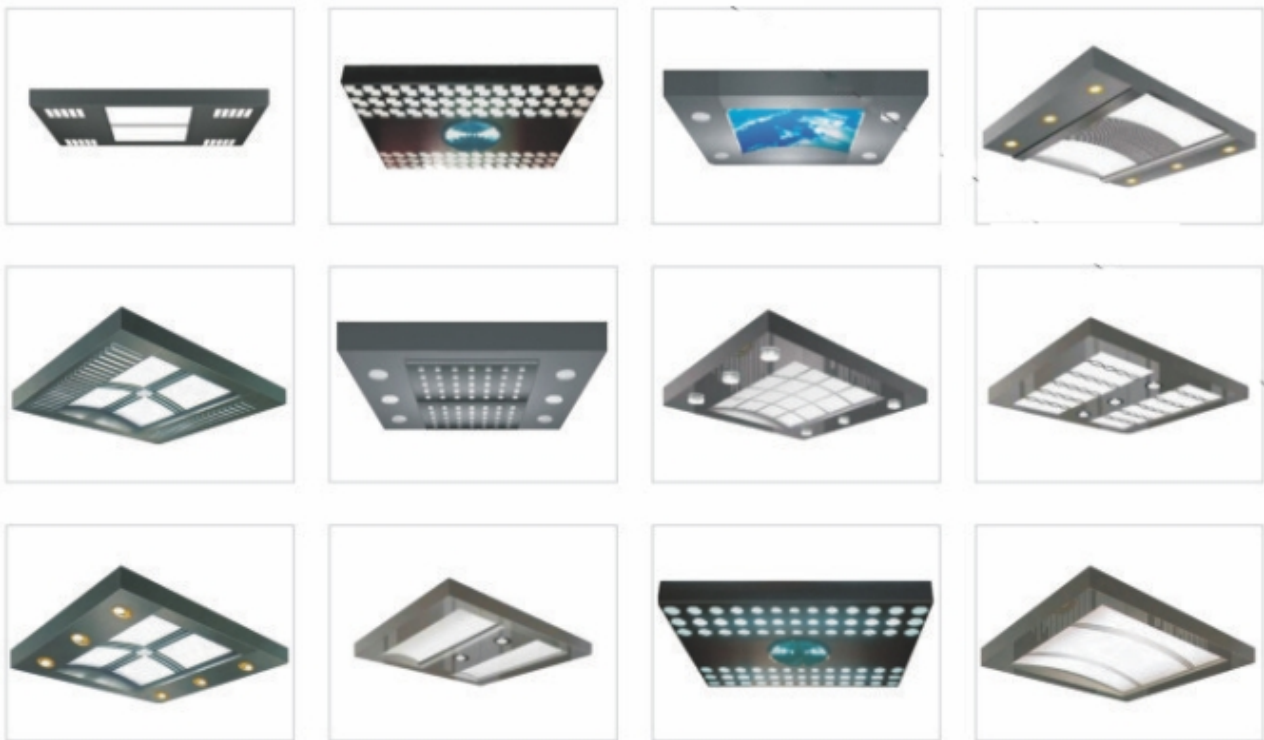

### FLOORING :

Premium quality material spelling durability, ability to take heavy foot traffic with easy maintenance options are used for flooring of elevators. Anti-Skid PVC flooring options are available in wooden Marble, sandalwood and many other finishes to augment the aesthetic appeal of the cabin.



## Goods Lifts with door entrances on the front only

100kg	1000	1000	1000	1200	1400*	1200	N/A	2350	2050
150kg	1000	1000	1000	1200	1400*	1200	N/A	2550	2250
200kg	1000	1000	1000	1200	1400*	1200	N/A	2550	2250
250kg	1000	1000	1000	1200	1400*	1200	N/A	2650	2250
300kg	1000	1000	1000	1200	1400*	1200	N/A	2650	2250

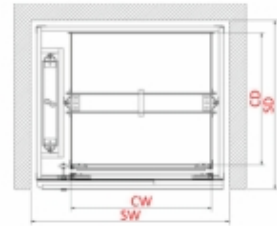

## Goods Lifts with door entrances on the front and back (thru car arrangement)

100kg	1000	1000	960	1200	1400*	1200	N/A	2350	2050
150kg	1000	1000	960	1200	1400*	1200	N/A	2550	2250
200kg	1000	1000	960	1200	1400*	1200	N/A	2550	2250
250kg	1000	1000	960	1200	1400*	1200	N/A	2650	2250
300kg	1000	1000	960	1200	1400*	1200	N/A	2650	2250

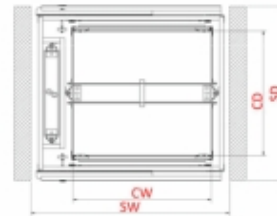

## Model 2050 & 2100 Lifts with door entrances on the front and side (adjacent car arrangement)

50kg	400	310	400	600	710*	550	900	2350	2050
50kg	530	410	500	800	910*	550	900	2550	2250
50kg	630	510	600	800	1010*	750	900	2550	2250
100kg	830	710	800	800	1230*	980	900	2650	2250

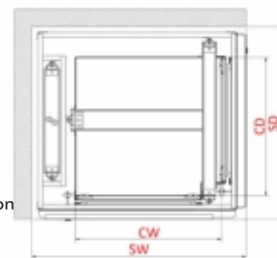

Incremental alteration to the car dimensions of 50mm can be made, with appropriate addition to the shaft and headroom measurements.

Bespoke car options are available for specific load dimensions or weight or where the shaft or headroom restricts installation of a standard lift.

\*Add 150mm to the shaft width for under driven models. Car fitted with safety gear, as required by the site conditions, may also need increased shaft width.

Bespoke designs, altering the sill and car heights, will affect the headroom.

## 1. Passenger lifts

Passenger elevator is designed to move people between floors of a building. Their capacity is related to available floor space. Upto 8-10 floors these operate at 1m/s and above 10 floors the speed starts at 2.5m/s to 10 m/s.

### System Design Concept

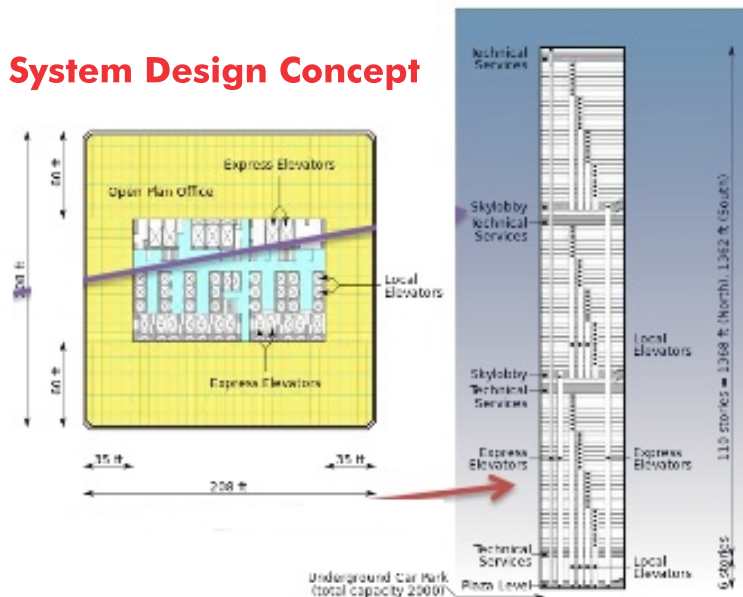

## LIFT WELL & CAR SIZE IN MM

For car door manually operated MS sliding door and landing MS swing door.

Capacity	CAR INSIDE		LIFTWELL		Entrance
	[A]	[B]	[C]	[D]	[E]
4 Passenger	1100	700	1600	1200	800
5 Passenger	1100	900	1600	1400	800
5 Passenger	1100	800	1600	1300	800
6 Passenger	1100	1000	1600	1500	800
6 Passenger	1100	940	1600	1450	800
6 Passenger	1100	800	1800	1300	800
8 Passenger	1100	1100	1700	1600	800
8 Passenger	1100	1000	1800	1500	800

Semi pod: car door power operated side opening door & landing MS swing door.

Capacity	CAR INSIDE		LIFTWELL		Entrance
	[A]	[B]	[C]	[D]	[E]
4 Passenger	1100	700	1600	1200	800
5 Passenger	1100	900	1600	1450	800
5 Passenger	1200	800	1600	1350	800
6 Passenger	1100	1000	1600	1550	800
6 Passenger	1200	900	1600	1450	800
6 Passenger	1400	800	1800	1350	800
8 Passenger	1300	1100	1700	1650	800
8 Passenger	1400	1000	1800	1550	800

### Passenger Elevators (With Centre Opening Power Operated Doors)

Capacity		Car Inside		Lift Well		CL. Opening		M/C Room	
Person	KG	A	B	C	D	E	H	C+( )	D+( )
6	408	1100	1100	1900	1600	800	2000	1500	2000
8	544	1300	1300	1900	1900	800	2000	1500	2000
10	680	1350	1350	1900	2100	800	2000	1500	2000
13	884	2000	2000	2500	1900	1900	2000	1500	2000
16	1088	2000	1300	2500	2100	1000	2000	1500	2500
20	1360	2000	1550	2500	2400	1000	2000	1500	2500

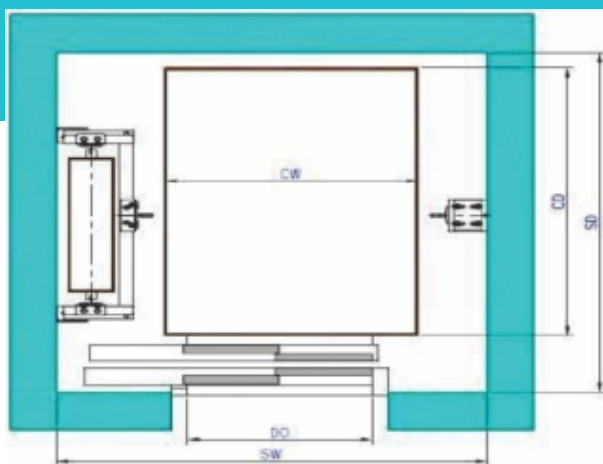

Arrangement (C)

### Arrangement (C)

Type	Q(kg)	Persons	CW(mm)	CD(mm)	DD(mm)	SW(mm)	SD(mm)
Type (I)	320	4	1000	900	800	1800	1500
			900	1000	800	1500	1500
	400	5	1100	1000	800	1700	1600
			1000	1100	800	1600	1600
	480	6	1200	1100	800	1850	1600
			1100	1200	800	1750	1600
630	8	1400	1100	800	1200	1800	
		1100	1400	800	1750	1800	
750	10	1200	1300	800	1850	1700	
		1400	1300	800	1200	1700	
800	10	1300	1400	800	1900	1800	
		1400	1350	800	2000	1000	
Type (II)	1000	13	1350	1400	800	2000	1800
			1600	1400	1100	2350	1850
	1050	14	1400	1600	1100	2100	2000
			1100	2100	800	1800	2500
	1350	18	1800	1500	1300	2400	1900
			1800	1800	1300	2400	2200
1600	21	2100	1800	1300	2000	2100	
		1400	2400	1300	2400	2800	

**NOTE :**

SD & SW VARY ACCORDING TO SELECTED DOOR SIZE, POSITION AND TYPE.

CW = Car Width. CD = Car Depth. DO = Door Opening. SW = Shaft Width.

CD = Shaft Depth Q = Rated Load

# BONUM<sup>®</sup>



Home Elevator installs and services residential elevators, designed to provide you with luxurious, yet affordable, vertical transportation for multi-level homes. We can customize your elevator to match your décor with our wide range of cab finishes and colors, and our innovative drive systems ensure your home elevator is reliable and quiet. Consider a residential elevator as an extension of your lifestyle, giving you freedom and flexibility.

# BONUM<sup>®</sup>

## Bonum Industries Pvt. Ltd.

An ISO 9001:2015, ISO 14001:2015 Certified Company

Plot No.: 30/3281, Near Ram Lila Padia, Meherpalli,  
Jharapada, Bhubaneswar, Odisha, Pin : 751006

Mob.: 7077700154, [www.bonumgroups.com](http://www.bonumgroups.com)

E-mail : [bonumgroups@gmail.com](mailto:bonumgroups@gmail.com), [sk.khatib@bonumgroups.com](mailto:sk.khatib@bonumgroups.com)  
[sayedmumtaz.ali@bonumgroups.com](mailto:sayedmumtaz.ali@bonumgroups.com)

